

Hollow output shaft

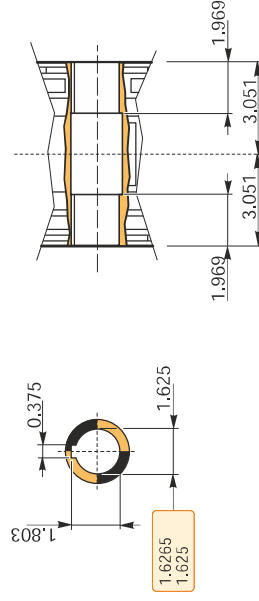

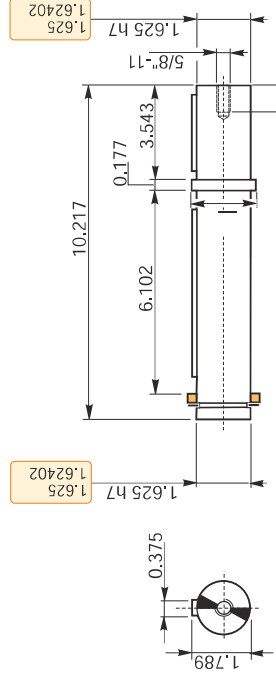

! Output shaft is delivered as loose accessory

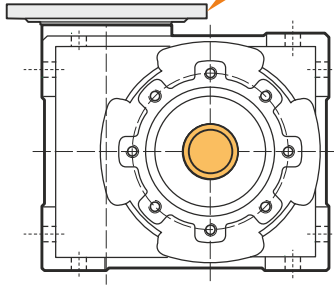
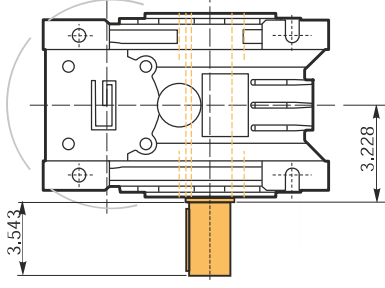
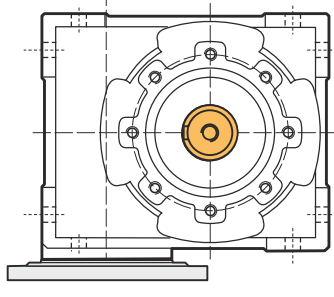
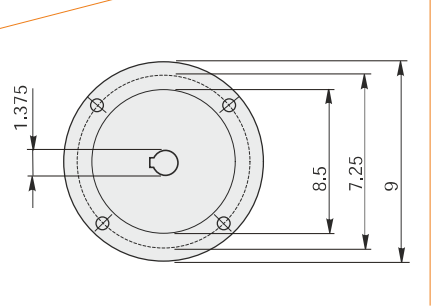

Mounting positions

M1 (B3)

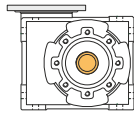

M2 (V6)

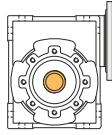

M3 (B8)

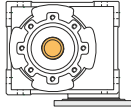

M4 (V5)

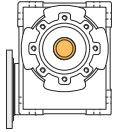

M5 (B7)

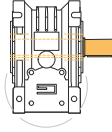

M6 (B6)

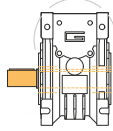

Oil quantity [quarts]

Lubricant type: this gear unit is delivered life lubricated

Direction of rotation

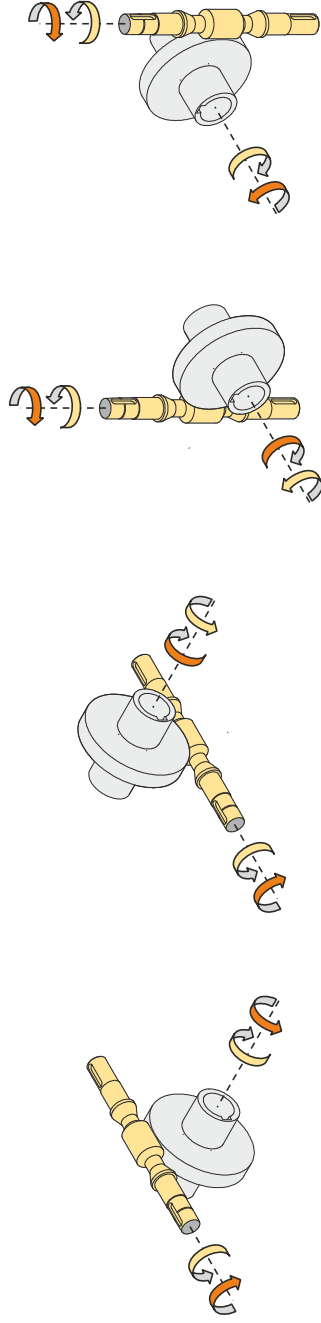

Weight

Gear unit [lb]

77.2

Gearing data

Number of starts

2

Lead angle

14° 41'

Pressure angle

20°

Backdriving

Variable static self-locking
Quick back-driving in case of vibrations
Dynamic back-driving